



HAL
open science

Sugar availability suppresses the auxin-induced strigolactone pathway to promote bud outgrowth

Jessica Bertheloot, Francois Barbier, Frédéric Boudon, Maria Dolores Perez-Garcia, Thomas Peron, Sylvie Citerne, Elizabeth Dun, Christine Beveridge, Christophe Godin, Soulaiman Sakr

► To cite this version:

Jessica Bertheloot, Francois Barbier, Frédéric Boudon, Maria Dolores Perez-Garcia, Thomas Peron, et al.. Sugar availability suppresses the auxin-induced strigolactone pathway to promote bud outgrowth. *New Phytologist*, 2020, 225 (2), pp.866-879. 10.1111/nph.16201 . hal-02402977

HAL Id: hal-02402977

<https://institut-agro-rennes-angers.hal.science/hal-02402977v1>

Submitted on 10 Dec 2019









HAL is a multi-disciplinary open access archive for the deposit and dissemination of scientific research documents, whether they are published or not. The documents may come from teaching and research institutions in France or abroad, or from public or private research centers.

L'archive ouverte pluridisciplinaire **HAL**, est destinée au dépôt et à la diffusion de documents scientifiques de niveau recherche, publiés ou non, émanant des établissements d'enseignement et de recherche français ou étrangers, des laboratoires publics ou privés.



Distributed under a Creative Commons Attribution - NonCommercial - ShareAlike 4.0 International License

Sugar availability suppresses the auxin-induced strigolactone pathway to promote bud outgrowth

Jessica Bertheloot^{1*} , François Barbier^{1,2*} , Frédéric Boudon³ , Maria Dolores Perez-Garcia¹, Thomas Péron¹, Sylvie Citerne⁴ , Elizabeth Dun² , Christine Beveridge² , Christophe Godin⁵  and Soulaïman Sakr¹ 

¹IRHS, INRA, Agrocampus-Ouest, Université d'Angers, SFR 4207 QuaSaV, 49071, Beaucouzé, France; ²School of Biological Sciences, The University of Queensland, St Lucia, QLD 4072, Australia; ³CIRAD, UMR AGAP & Univ. Montpellier, Avenue Agropolis, TA A-108/01, F-34398, Montpellier, France; ⁴Institut Jean-Pierre Bourgin Centre de Versailles-Grignon (IJPB), INRA, Agro-ParisTech, CNRS, Versailles, France; ⁵Laboratoire Reproduction et Développement des Plantes, University of Lyon, ENS de Lyon, UCB Lyon 1, CNRS, INRA, Inria, F-69342, Lyon, France

Summary

Author for correspondence:

Jessica Bertheloot

Tel: +33 241 225632

Email: jessica.bertheloot@inra.fr

Received: 29 April 2019

Accepted: 9 September 2019

New Phytologist (2019)

doi: 10.1111/nph.16201

Key words: auxin, branching, bud, hormones, model, strigolactones, sucrose, sugar.

- Apical dominance occurs when the growing shoot tip inhibits the outgrowth of axillary buds. Apically-derived auxin in the nodal stem indirectly inhibits bud outgrowth via cytokinins and strigolactones. Recently, sugar deprivation was found to contribute to this phenomenon.
- Using rose and pea, we investigated whether sugar availability interacts with auxin in bud outgrowth control, and the role of cytokinins and strigolactones, *in vitro* and *in planta*.
- We show that sucrose antagonises auxin's effect on bud outgrowth, in a dose-dependent and coupled manner. Sucrose also suppresses strigolactone inhibition of outgrowth and the *rms3* strigolactone-perception mutant is less affected by reducing sucrose supply. However, sucrose does not interfere with the regulation of cytokinin levels by auxin and stimulates outgrowth even with optimal cytokinin supply. These observations were assembled into a computational model in which sucrose represses bud response to strigolactones, largely independently of cytokinin levels. It quantitatively captures our observed dose-dependent sucrose-hormones effects on bud outgrowth and allows us to express outgrowth response to various combinations of auxin and sucrose levels as a simple quantitative law.
- This study places sugars in the bud outgrowth regulatory network and paves the way for a better understanding of branching plasticity in response to environmental and genotypic factors.

Introduction

Shoot branching in plants is one of the major traits that affects the fitness of wild species in natural environments and the yield potential of agricultural, horticultural and forestry crops (Evers *et al.*, 2011; Pierik & Testerink, 2014; Mathan *et al.*, 2016). Shoot branching markedly depends on the outgrowth of dormant or very slow growing axillary buds that form in the axils of leaves. Bud outgrowth is a highly plastic process and its regulation involves a complex network of several interacting endogenous and exogenous cues (Rameau *et al.*, 2015).

Apical dominance is the term used to describe the inhibitory effect that the growing shoot tip exerts, at a distance, over the outgrowth of the axillary buds below. This systemic regulation is demonstrated by experiments in which bud outgrowth is released after shoot tip decapitation.

Auxin, a plant hormone produced in the apical region and transported downwards through the stem, was considered

important in the maintenance of apical dominance (Ongaro & Leyser, 2008). Indeed, exogenous auxin applied to the decapitated shoot tip can often restore bud outgrowth inhibition (Thimann & Skoog, 1933). However, auxin alone is insufficient to explain apical dominance. Firstly, for particular species and growing conditions, the supply of exogenous auxin to decapitated plants cannot completely restore apical dominance, suggesting that a factor other than auxin is involved (Cline, 1996). Secondly, correlative studies have shown that auxin transport, typically at 1 cm h⁻¹ through the stem, is too slow for local auxin depletion, following decapitation, to precede the onset of outgrowth of the basal bud in garden pea (Morris *et al.*, 2005; Renton *et al.*, 2012).

A recent study in pea (Mason *et al.*, 2014) indicated that the high demand for sugars by the growing shoot tip is an essential regulator of apical dominance. Following decapitation of the growing shoot tip, sugars rapidly redistributed (moving at *c.* 150 cm h⁻¹) and accumulated in the basal node and bud, before the onset of bud outgrowth, and while auxin levels in the adjacent node remained unchanged. This indicated that sugars might be the initial trigger of bud outgrowth after decapitation.

*These authors contributed equally to this work.

This hypothesis was confirmed in the same study by showing that exogenous sugar supply through the petiole of plants with intact growing shoot tips was sufficient to induce bud outgrowth despite the presence of auxin in the stem. Furthermore, decreasing sugar levels through defoliation in decapitated plants delayed bud outgrowth. Additional studies in other species also support a role for sugars in apical dominance. Partial defoliation of sorghum plants reduced the number of sugar sources, lowered sugar levels in the bud, and inhibited bud outgrowth (Kebrom & Mullet, 2015). The *tin* mutant of wheat, which has enhanced stem growth and therefore demand for sugars, shows reduced tillering (Kebrom *et al.*, 2012; Kebrom & Mullet, 2015). Sugars are proposed to play a signalling role in bud outgrowth regulation (Rabot *et al.*, 2012; Barbier *et al.*, 2015a; Barbier *et al.*, 2015b). This process may be mediated, at least in part, by trehalose 6-phosphate, whose level indicates sucrose availability in plants (Figueroa & Lunn, 2016; Fichtner *et al.*, 2017).

While these data highlight that sugars and auxin are critically important mediators of apical dominance, until now, the roles of auxin and sugars in the regulation of bud outgrowth have been studied independently and whether these two pathways interact during this process is still an open question.

Auxin in the main stem acts indirectly on lateral buds as it does not enter the bud (Booker *et al.*, 2003) and potentially act via two mechanisms involving cytokinins and strigolactones (Domagalska & Leyser, 2011 for review). In the first mechanism known as ‘the auxin canalisation theory’, auxin in the stem acts via preventing the establishment and maintenance of auxin flow from axillary buds, a process promoting bud outgrowth (Prusinkiewicz *et al.*, 2009; Balla *et al.*, 2011). Within this, strigolactones and cytokinins respectively inhibit and promote auxin transport and export from axillary buds to the main stem (Shinohara *et al.*, 2013; Waldie & Leyser, 2018). However, recent findings in garden pea indicate that auxin canalisation out of the bud is not involved in the initial stage of bud outgrowth, but that it would rather affect the sustained growth of already activated buds (Chabikwa *et al.*, 2018).

In the second mechanism, called ‘the second messenger theory’, auxin regulates the production of cytokinins and strigolactones that respectively induce or inhibit bud outgrowth (Sachs & Thimann, 1967; Gomez-Roldan *et al.*, 2008; Umehara *et al.*, 2008). Indeed, cytokinin biosynthesis and levels are rapidly enhanced in the nodal stem by auxin depletion (induced for example by decapitation, stem segment excision or application of an auxin transport inhibitor), and these phenomena can be prevented by exogenous auxin (Nordstrom *et al.*, 2004; Tanaka *et al.*, 2006). Conversely, the expression of strigolactone biosynthesis-related genes is rapidly repressed by auxin depletion in the stem, a behaviour that is also prevented by exogenous auxin application (Foo *et al.*, 2005; Zou *et al.*, 2006; Hayward *et al.*, 2009). Cytokinins and strigolactones are partly integrated within the bud by the transcription factor BRC1, involved in bud dormancy in several species (Aguilar-Martinez *et al.*, 2007; Dun *et al.*, 2012; Rameau *et al.*, 2015; Wang *et al.*, 2019).

Interestingly, sugars have been reported to have an opposite effect to auxin on cytokinins and strigolactones in different

developmental processes (Arrom & Munne-Bosch, 2012; Li *et al.*, 2016; Tian *et al.*, 2018) including in bud outgrowth (Barbier *et al.*, 2015b; Barbier *et al.*, 2019). In our previous study on rose isolated nodal segments grown without auxin (Barbier *et al.*, 2015b), we highlighted that sucrose stimulated bud outgrowth and that this growth was preceded by downregulated strigolactone signalling gene expression and increased cytokinin synthesis. This effect is opposite to the effects of auxin on cytokinin and strigolactone biosynthesis (Tanaka *et al.*, 2006; Hayward *et al.*, 2009). These correlative trends indicate that increased sugar availability may antagonise auxin during the control of bud outgrowth and place strigolactones and cytokinins as potential integrators of such antagonism (Fig. 1). In this study, we used physiological experiments to determine if and how sucrose, the main transported form of sugar in plants, and auxin interact to control bud outgrowth. Then, we tested the ability of this qualitative sugar–auxin interacting network to reproduce quantitatively the observed data using computer modelling and derived from this model a simple law synthesising the diversity of bud outgrowth response to the various combinations of sucrose and auxin levels.

Materials and Methods

Plant material and treatments

Rose plants used were primary axes of *Rosa hybrida* L. cv Radrazz obtained from cuttings. Pea plants used were *Pisum sativum* L. cv Terese (wild-type or *rms3* mutant) obtained from seeds. Environmental conditions for all experiments are described in Supporting Information Table S1. Overbranched *rms3* mutants were grown under very low light intensities ($70\text{--}80\ \mu\text{mol m}^{-2}\ \text{s}^{-1}$) to maintain buds in a state of dormancy until the transfer of nodal segments to *in vitro* conditions.

In vitro experiments involved the growth of nodal segments on Murashige and Skoog (MS) medium supplemented with different concentrations of sucrose (10, 50, 100, 250 mM), glucose

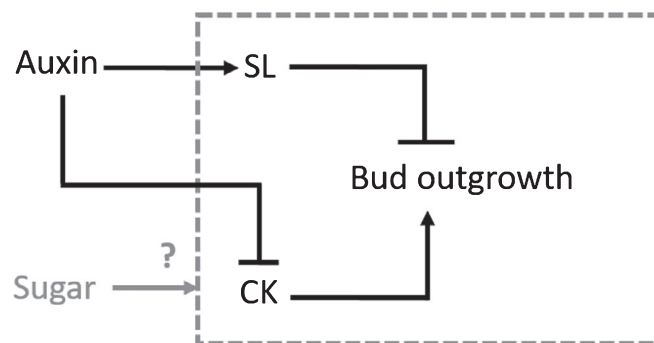

Fig. 1 The interaction between sugar and auxin in the control of bud outgrowth is an open question. Auxin represses cytokinins (CK) and stimulates strigolactones (SL), which are stimulators and repressors of bud outgrowth, respectively (Beveridge *et al.*, 2000; Sorefan *et al.*, 2003; Nordstrom *et al.*, 2004; Foo *et al.*, 2005; Tanaka *et al.*, 2006; Zou *et al.*, 2006; Hayward *et al.*, 2009) (black). We test whether sugar interacts with auxin to control bud outgrowth via strigolactones and/or cytokinins (grey).

(200 mM), fructose (200 mM), 100 mM glucose with 100 mM fructose, 1-naphthaleneacetic acid (NAA; 0, 1, 2.5 μ M), rac-GR24 (5 μ M) and 6-benzylaminopurine (BAP; 10 μ M), previously used in *in vitro* studies (Chiou & Bush, 1998; Rabot *et al.*, 2012; Barbier *et al.*, 2015b; Waldie & Leyser, 2018). For BAP, 10 μ M is the optimum concentration that stimulates bud outgrowth for rose (Fig. S4). Except for Fig. 4(b), nodal segments were excised from the third true leaf-bearing node when the floral bud became visible for rose and when the fourth true leaf was fully expanded for pea, and were placed on horizontal plates. For Fig. 4b, nodal segments were excised from nodes five and six from plants with five or six expanded true leaves and placed in upright open tubes (Brewer *et al.*, 2015). Details are given in Methods S1.

Experiments on decapitated plants of rose involved cutting 2 cm above the fourth leaf when the floral bud became visible. For all experiments, NAA (10 μ M) was supplied in a basic medium to the decapitated stump. As shown in Fig. 2a, plants were either nondefoliated or partially defoliated. In Fig. 2b, plants were: (1) partially defoliated and supplied at the second topmost leaf with mannitol (50 mM) or sucrose (50 mM) as described in (Lin *et al.*, 2011); or (2) partially defoliated except at the second topmost leaf. As shown in Fig. 4c, plants were partially defoliated and vascularly supplied with GR24 (5 μ M) 1 cm below the second downmost node, as described in Corot *et al.* (2017). Partial defoliation consisted of removing four out of the five leaflets at each node. The methods for supply of hormones and sugars are described in Methods S2.

Bud outgrowth

Buds *in vitro* were photographed daily and bud length was quantified using IMAGEJ software (<https://imagej.nih.gov/ij/>). Rose buds display a phase of slow elongation followed by a phase of rapid elongation (Barbier *et al.*, 2015b). A bud was considered to grow out if it entered a phase of rapid elongation. The time at which the bud grew out was estimated, as described in Methods S3. For decapitated rose plants, the state of each bud (outgrowing or not) along the stem and bud length was measured daily. A bud was considered to grow out if at least one visible leaf protruded between the two bud scales.

Cytokinin concentrations

Cytokinin content of the nodal stem was determined as previously described (Barbier *et al.*, 2015b) (retention times, limits of quantification and detection described in Table S2). Nodal stem was defined as the bud and nodal segments with 5 mm of stem of each side of the node.

Sugar concentrations

Internodes of decapitated rose plants were harvested 24 h after plants had been decapitated. Individual internodes were

identified by their rank from shoot top. They were frozen in liquid nitrogen, lyophilised and ground to a fine powder. Sucrose and starch contents were determined as described in Methods S4.

Statistical analysis

Statistical analyses were done using R software for Windows. The functions `aov()`, `TukeyHSD()`, `wilcox.test()` and `fisher.test()` were used for analysis of variance (ANOVA), Tukey multiple comparison test, Wilcoxon's test and Fisher's test, respectively.

Model equations

The computational model is schematically described in Fig. 5(a) and model parameters are listed in Table S3.

The levels of auxin (A) and sucrose (S) control the synthesis of cytokinins (CK) and strigolactones (SL) and the rates of change in the levels of cytokinins and strigolactones within a time step (dt) were described using a system of ordinary differential equations:

$$\frac{dCK}{dt} = \frac{c_1}{1 + b_1 A} + a_1 \frac{S^2}{k_1 + S^2} - d_1 CK \quad \text{Eqn 1}$$

where c_1 , b_1 , a_1 , k_1 and d_1 are constants (see Table S3 for definition, units and values). The first term corresponds to auxin-repressed cytokinin synthesis, the second term corresponds to sucrose-stimulated cytokinin synthesis (effects are supposed to be cumulative) and the last term to cytokinin-dependent cytokinin degradation.

$$\frac{dSL}{dt} = c_2 + a_2 \frac{A^2}{k_2 + A^2} - d_2 SL \quad \text{Eqn 2}$$

where c_2 , a_2 , k_2 and d_2 are constants (see Table S3 for definition, units and values). The first term is the base synthesis rate, the second term is auxin-stimulated synthesis and the last term is strigolactone-dependent degradation.

Cytokinins and strigolactones control the synthesis of the signal integrator I and I changes within a time step as follows:

$$\frac{dI}{dt} = c_3 + a_3 \frac{SL^2}{1 + b_3(S)SL^2} + a_4 \frac{1}{1 + k_3 CK^2} - d_3 I \quad \text{Eqn 3}$$

$$\text{with } b_3(S) = u_1 + u_2 S^2 \quad \text{Eqn 4}$$

and where c_3 , a_3 , a_4 , k_3 , d_3 , u_1 and u_2 are constants (see Table S3 for definition, units and values). The first term is the base synthesis, the second term is strigolactone response, the third term is cytokinin response and the last term I -dependent degradation. Inhibitor response is an increasing function of strigolactone level

Decapitated rose

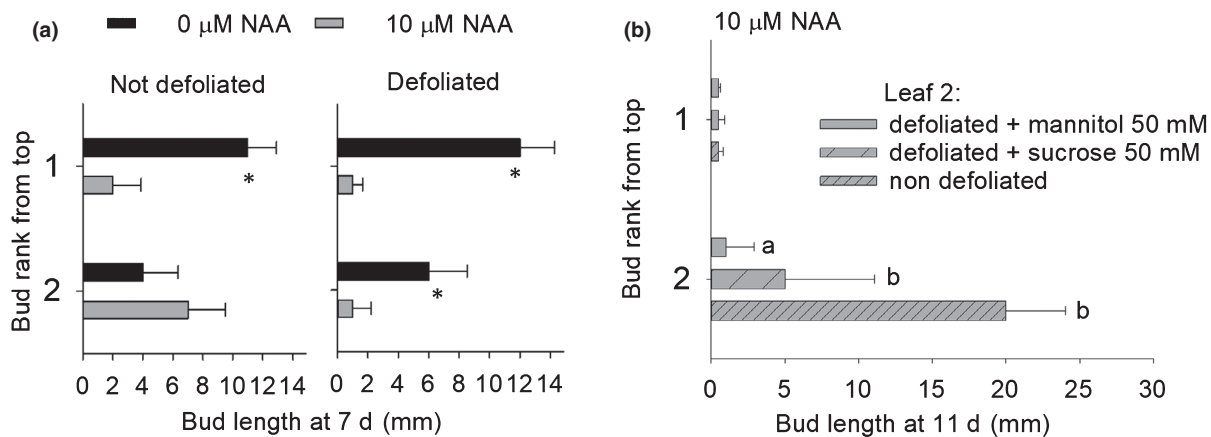
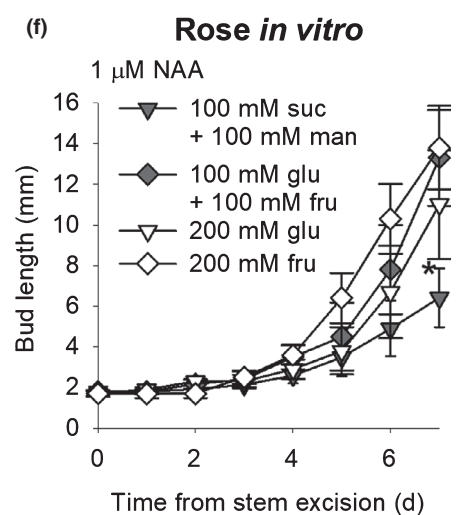
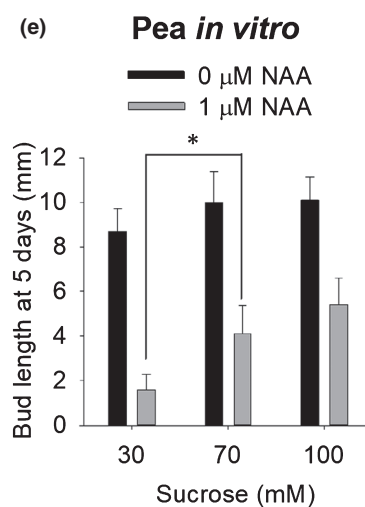
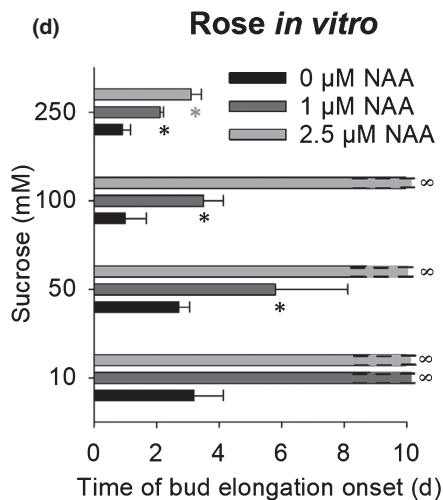
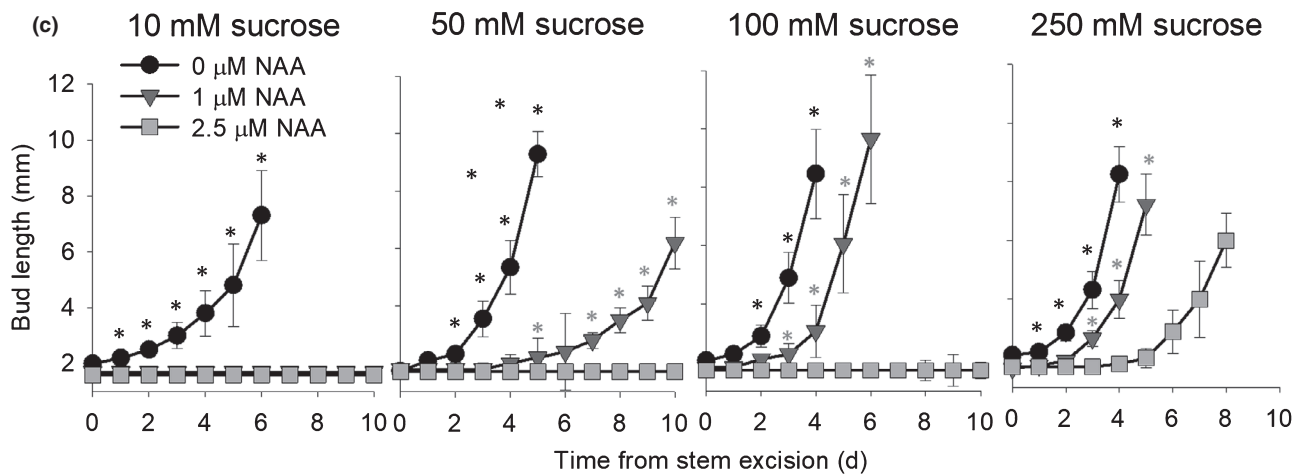
Rose *in vitro*

and is repressed by sucrose level. It is also a decreasing function of cytokinin level.

We assume in addition that the level of I correlates with the time at which bud outgrowth starts (T). A threshold (I_0) determines if T is finite or infinite (bud outgrowth completely prevented), as follows:

$$T = m_0 + m_1 I \quad \text{if } I < I_0$$

$$T = \infty \quad \text{otherwise}$$

Eqn 5

The model was implemented in PYTHON (<https://www.python.org/>).

Fig. 2 Sugars and auxin act antagonistically and in a coupled and dose-dependent manner in the control of bud outgrowth. (a) Effect of NAA, a synthetic auxin, on the length of the two topmost buds of rose plants previously decapitated and either nondefoliated or partially defoliated. Data are medians ($n = 6$). Asterisks indicate significant differences between NAA treatments (Wilcoxon's test; $P < 0.05$). (b) Bud length response to sucrose supply to the second topmost leaf of partially defoliated and decapitated rose plants supplied with NAA, compared with a mannitol supply (osmotic control) and compared with a plant in which the second leaf is not defoliated. Only the two topmost buds are represented. Data are medians ($n = 8$). Letters indicate significant differences between treatments (Wilcoxon's test; $P < 0.05$). (c, d) Bud outgrowth response to NAA for nodal segments of rose grown *in vitro* with increasing levels of sucrose: (c) elongation kinetics of the bud with the median final length ($n = 10$); (d) median time at which elongation starts, unclosed horizontal bars (with the symbol ∞) representing no bud outgrowth. Black asterisks indicate significant differences between 0 and 1 μM NAA; grey asterisks indicate significant differences between 1 and 2.5 μM NAA (Wilcoxon's test; $P < 0.05$). (e) Bud length response to NAA for nodal segments of pea grown *in vitro* with increasing levels of sucrose. Data are medians ($n = 9$). The asterisk indicates a significant difference between sucrose treatments (Wilcoxon's test; $P < 0.01$). (f) Bud elongation response to 100 mM sucrose (suc) with 100 mM mannitol (man), the co-supply of 100 mM glucose (glc) and 100 mM fructose (fru), 200 mM glucose, or 200 mM fructose, for nodal segments of rose grown with 1 μM NAA. The bud with the median final length is represented for each treatment ($n = 10$). Asterisks indicate significant differences between suc treatment and glc/fru treatments at 7 d (Wilcoxon's test; $P < 0.05$). For all graphs, error bars represent 95% confidence intervals.

Model calibration

Our model takes auxin and sucrose levels as an input and estimates corresponding delays in bud outgrowth. It relies on kinetic parameters whose values are in general not known. Here, we exploit our isolated bud system to indirectly estimate these kinetic parameters. For this, we experimentally fixed concentrations of input variables in the isolated bud medium and measured values of output variables. We could then use these pairs of observed input/output observed values to estimate plausible values of the kinetic parameters. The imposed and measured values are detailed in Table S4.

Based on different combinations of imposed input values, we used a gradient algorithm to infer model parameters. We varied the initial point in the parameter space by performing a sample of 1000 simulations starting from initial values of parameters randomly selected in a range of (0, 1000) for all parameters except for decay parameters selected in a range of (0, 1). The gradient algorithm was achieved using the function least squares of the module *scipy* to estimate each parameter value (<http://scipy.org/>). The function optimised the different parameters of the model by minimising the relative errors between measured values and estimated values of CK and T . Estimated parameter values are listed in Table S3.

For each simulation, the algorithm converged to an optimised set of parameter values associated with a least square error threshold ($0.60 \pm 1e-6$). Interestingly, we observed that the optimised parameter values did not depend much on their initial value and had very close values (standard deviation $< 1e-2$ for set of values of each parameter), suggesting that the numerical estimation of the parameters in this system is particularly robust.

Results

Auxin and sugar control bud outgrowth in an antagonistic, coupled and dose-dependent manner

We first evaluated the existence of an antagonistic effect of sugar supply and auxin in the regulation of axillary bud outgrowth. We performed physiological experiments using decapitated rose plants, in a species in which we have previously established the action of sugars on bud outgrowth (Barbier *et al.*, 2015b) and manipulated levels of both auxin and sugar available to buds.

Auxin levels were altered by treating the decapitated stump with or without 1-naphthaleneacetic acid (NAA), a stable synthetic auxin. Sugar availability was manipulated by partial defoliation that is well known to reduce plant sugar status (Kebrom & Mullet, 2015). The inhibitory effect of auxin was stronger in partially defoliated plants than in nondefoliated plants, in a manner that was negatively correlated with plant sugar status (Figs 2a, S1). While auxin only inhibited the topmost bud of nondefoliated plants, the second topmost bud was also inhibited in partially defoliated plants (Fig. 2a), which had lower sugar levels than nondefoliated plants (Fig. S1). Defoliation could affect sugar status but also other physiological variables (e.g. transpiration stream, xylem-transported molecules; Cerasoll *et al.*, 2004; Lestienne *et al.*, 2006; Eyles *et al.*, 2013). Here, we show that sugar contributes to the bud outgrowth stimulation seen in nondefoliated plants compared with defoliated plants, because bud outgrowth was significantly induced at the second topmost node of defoliated plants when sucrose was supplied to its petiole or when its leaf was nondefoliated, but not with mannitol, an osmotic control (Fig. 2b). This finding is in agreement with the observation that auxin does not inhibit bud outgrowth in intact garden pea plants when sucrose is exogenously supplied (Mason *et al.*, 2014). These results support the idea that sugars and auxin regulate bud outgrowth in an antagonistic manner.

We then quantified the antagonistic effects of sugars and auxin on bud outgrowth using single nodal segments grown in split plates *in vitro*. This system has successfully been used in previous studies to easily manipulate the levels of several regulators of bud outgrowth (Chatfield *et al.*, 2000; Rabot *et al.*, 2012; Waldie & Leyser, 2018). The form of sugar used was sucrose, which is the main transported form of sugars in plants (Lemoine *et al.*, 2013). Sucrose concentration in the phloem sap varies greatly between plant species, ranging from 100–900 mM (Ohshima *et al.*, 1990; Nadwodnik & Lohaus, 2008; Jensen *et al.*, 2013). In peach, a rosacea species like rose, sucrose concentration in the phloem sap has been reported to be about 200 mM (Nadwodnik & Lohaus, 2008). The supply of 100 mM sucrose to rose nodal segments *in vitro* could antagonise the inhibiting effect of 1 μM NAA on bud outgrowth; this was not the case for 100 mM mannitol (Fig. S2).

To quantify the antagonistic effect of sucrose and auxin *in vitro*, we used sucrose concentrations ranging from 10 to 250 mM. Bud outgrowth is a continuous process, often measured

as elongation of the bud through time and that can be divided into a lag period before growth starts and a period of rapid growth (Chatfield *et al.*, 2000; Barbier *et al.*, 2015b). As done previously for rose, we quantitatively described bud outgrowth response by measuring whether or not buds grow out as well as the time at which their growth commenced (Barbier *et al.*, 2015b). In addition to rose, we here included garden pea, which has also previously been used to establish the importance of sugars in bud outgrowth (Mason *et al.*, 2014).

At low sucrose concentration (10 mM), rose buds grew out in the absence of NAA and were completely repressed by 1 and 2.5 μM NAA (Fig. 2c). At intermediate sucrose concentrations (50 and 100 mM), high NAA (2.5 μM) completely suppressed bud outgrowth, while intermediate NAA (1 μM) only delayed the time at which elongation started (Fig. 2d). This delay was inversely correlated to sucrose level (intermediate NAA delayed elongation by *c.* 6 d and 3.5 d for 50 and 100 mM, respectively). At a high sucrose concentration (250 mM), NAA was no longer able to completely suppress bud outgrowth (Fig. 2c), but delayed in a dose-dependent manner the time at which elongation started (Fig. 2d). This result highlighted that sucrose only partially removed the inhibitory effect of auxin. This effect of sucrose was also observed for nodal segments of garden pea *in vitro* (Fig. 2e).

Interestingly, the amplitude of the sucrose effect depended on auxin level. At high auxin levels (2.5 μM NAA), the effect of a given change in sucrose level on bud outgrowth was high (reduction in the time of elongation onset of > 5% between 100 and 250 mM sucrose), while it remained intermediate (reduction of 2% between 50 and 250 mM sucrose) at intermediate auxin levels (1 μM NAA) and low (reduction of 1% between 10 and 250 mM sucrose) at 0 μM NAA. This difference shows that sucrose and auxin have a coupled effect on bud outgrowth. Two-way ANOVA analysis also indicated a significant interaction between auxin and sucrose at the time at which elongation started (P -value < 10^{-4}).

All these results indicated that sugar partially antagonises the effect of auxin on bud outgrowth in a coupled manner and that combined sugar and auxin levels quantitatively modulate bud outgrowth by determining whether buds grow and the time at which their growth starts. In tissues, sucrose can be hydrolysed into glucose and fructose. We have previously reported that glucose and fructose could trigger bud outgrowth, as found for sucrose, in the absence of auxin in the growth medium (Rabot *et al.*, 2012). We therefore decided to compare the effect of sucrose (100 mM sucrose + 100 mM mannitol) with that of glucose (200 mM), fructose (200 mM), or glucose (100 mM) and fructose (100 mM) in the presence of auxin. The sucrose condition was adjusted with mannitol to achieve the same osmolarity for all conditions. The co-supply of glucose and fructose triggered bud outgrowth and antagonised the effect of auxin more efficiently than sucrose (Fig. 2f). The same trend was found when buds were fed exclusively with glucose or fructose. These findings indicated that glucose and fructose are unlikely to act through their reconversion into sucrose and that the effect of sucrose could involve different sugar signalling pathways.

Current knowledge has led to a model in which auxin in the nodal stem inhibits the early stage of bud outgrowth through modulation of cytokinin and strigolactone levels (Domagalska & Leyser, 2011). As sucrose supply to rose nodal stem segments induces rapid changes in cytokinin levels and strigolactone signalling (Barbier *et al.*, 2015b), we sought to determine the role of these two hormones in the modulation of bud outgrowth by sugar–auxin interactions.

Sugar availability modulates bud outgrowth independently of cytokinin levels

The suppression of nodal cytokinin content by auxin was the first hormonal mechanism proposed to explain the indirect action of auxin in apical dominance (Shimizu-Sato *et al.*, 2009). Our previous study demonstrated that sucrose supply to nodal segments of rose *in vitro* could upregulate cytokinin synthesis (Barbier *et al.*, 2015b). We therefore tested whether auxin and sucrose might antagonistically affect cytokinin levels in our isolated rose bud system. There was a substantial and widespread suppressive effect of NAA on endogenous cytokinins, regardless of the sucrose concentration in the growth medium (Figs 3a, S3). In the presence of 2.5 μM NAA, increasing sucrose from 100 to 250 mM caused no significant increase in cytokinins (Fig. 3a), while inducing a clear positive response in bud outgrowth (Fig. 2c,d). This contrast in effect of sucrose on bud outgrowth vs cytokinin levels was also observed in the presence of 1 μM NAA. In this case, increasing sucrose concentration from 50 to 100 mM did not significantly increase cytokinin, while reducing the delay before bud elongation (Fig. 2c,d vs Fig. S3). These results indicated that only a minor component of the stimulatory effect of sugar on bud outgrowth may occur via sugar modulation of cytokinin levels in the rose single node.

To confirm this result, we supplied NAA-inhibited buds with synthetic cytokinin (6-benzylaminopurine (BAP)) at a 10 μM concentration that was optimum for bud outgrowth (above this concentration, there was no further stimulation of bud outgrowth; Fig. S4) and tested the impact of two sucrose concentrations on bud response. As expected, in the absence of cytokinins, the addition of 2.5 μM NAA inhibited buds at both 50 and 100 mM sucrose (Fig. 3b). Cytokinin supply triggered bud outgrowth under both sucrose conditions but, interestingly, the time at which outgrowth started was sucrose dependent (Fig. 3b). Cytokinin-treated buds elongated earlier under the higher sucrose concentration. Similarly for pea, cytokinin supply released buds from NAA inhibition at both 30 and 100 mM sucrose and cytokinin-treated buds were longer at high sucrose levels rather than at low sucrose levels (Fig. 3c). Therefore, even in the presence of exogenously supplied cytokinin, sucrose was still able to promote bud outgrowth. Combined with the observation that cytokinin levels only showed a minor response to sucrose in the presence of auxin, these data supported the premise that sugar acts largely independently of cytokinin levels to stimulate bud outgrowth in presence of auxin.

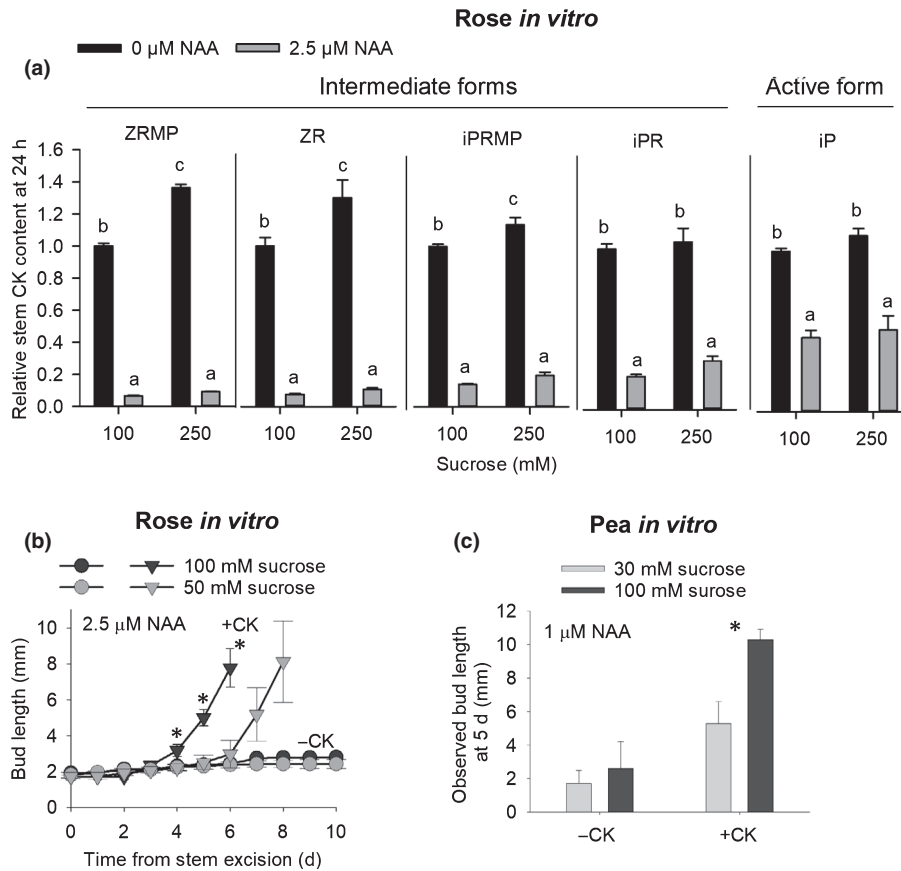

Fig. 3 Sucrose acts independently of cytokinin levels. (a) Response of nodal cytokinins to NAA, a synthetic auxin, for nodal segments of rose grown *in vitro* with increasing levels of sucrose. Data are means \pm SE ($n = 4$ pools of three stem segments). Expression data were measured 24 h after nodal stem excision. Values are represented relative to the treatment 100 mM sucrose and 0 μ M NAA. Different letters indicate significant difference between means (two-way ANOVA followed by Tukey's test; $P < 0.05$). (b, c) Impact of BAP, a synthetic cytokinin (–CK/+CK), on the inhibition of bud outgrowth by NAA for nodal segments of rose (b) and pea (c) grown *in vitro* with two sucrose concentrations: (b) elongation kinetics of the bud with the median final length ($n = 10$); (c) median bud length at 5 d ($n = 9$). Error bars represent 95% confidence intervals. Asterisks indicate significant differences between sucrose treatments in presence of BAP (Wilcoxon's test; $P < 0.01$).

The sugar pathway acts by suppressing bud response to strigolactones

Previous studies have shown that sucrose does not repress the expression of strigolactone synthesis genes, but downregulates the expression of a strigolactone signalling gene (Kebrom *et al.*, 2010; Barbier *et al.*, 2015b). We reasoned that sucrose may downregulate or suppress the response of the bud to strigolactones, rather than regulating strigolactone synthesis. To examine the effect of sugars on the strigolactone bud-inhibition response, we exposed rose nodal segments *in vitro* to different sucrose concentrations with an intermediate auxin concentration that would potentially enable a strigolactone-inhibition response (Crawford *et al.*, 2010). At 50 mM sucrose, the supply of GR24, a synthetic strigolactone, in the growth medium was able to greatly suppress bud outgrowth (Fig. 4a). However, at 100 mM sucrose, this effect was completely suppressed. The same trend was observed when replacing sucrose with glucose and/or fructose (Fig. S5). Altogether, this result shows that sugar availability suppresses the strigolactone inhibition of bud outgrowth.

Similar results were observed for pea, except in this case the addition of auxin in the medium was unnecessary (Brewer *et al.*, 2015). GR24 had a significant inhibitory effect at 10 and 30 mM sucrose in pea, but was ineffective at 100 mM sucrose (Fig. 4b), indicating that the ability of sugar to repress the bud response to strigolactones is conserved in diverse species.

To test this hypothesis *in planta*, we decapitated rose plants supplied with different levels of leaf-supplied sugars modulated by defoliation, as carried out previously (Figs 2c, S1). GR24 was more effective at inhibiting bud outgrowth at high defoliation than without defoliation (Fig. 4c).

To further test whether sugar inhibits the strigolactone response to stimulate bud outgrowth, we compared the responses of the wild-type and the *rms3* strigolactone-perception mutant (de Saint Germain *et al.*, 2016) to variations in sucrose concentrations, with or without NAA. These concentrations allowed us to have a variability in the percentage of bud outgrowth for the wild-type (Fig. 4d). Compared with wild-type, *rms3* bud outgrowth was less responsive to a decrease in sucrose concentration. At the highest sucrose concentration (30 and 70 mM for 0 and 1 μ M NAA, respectively), wild-type and *rms3* exhibited 100%

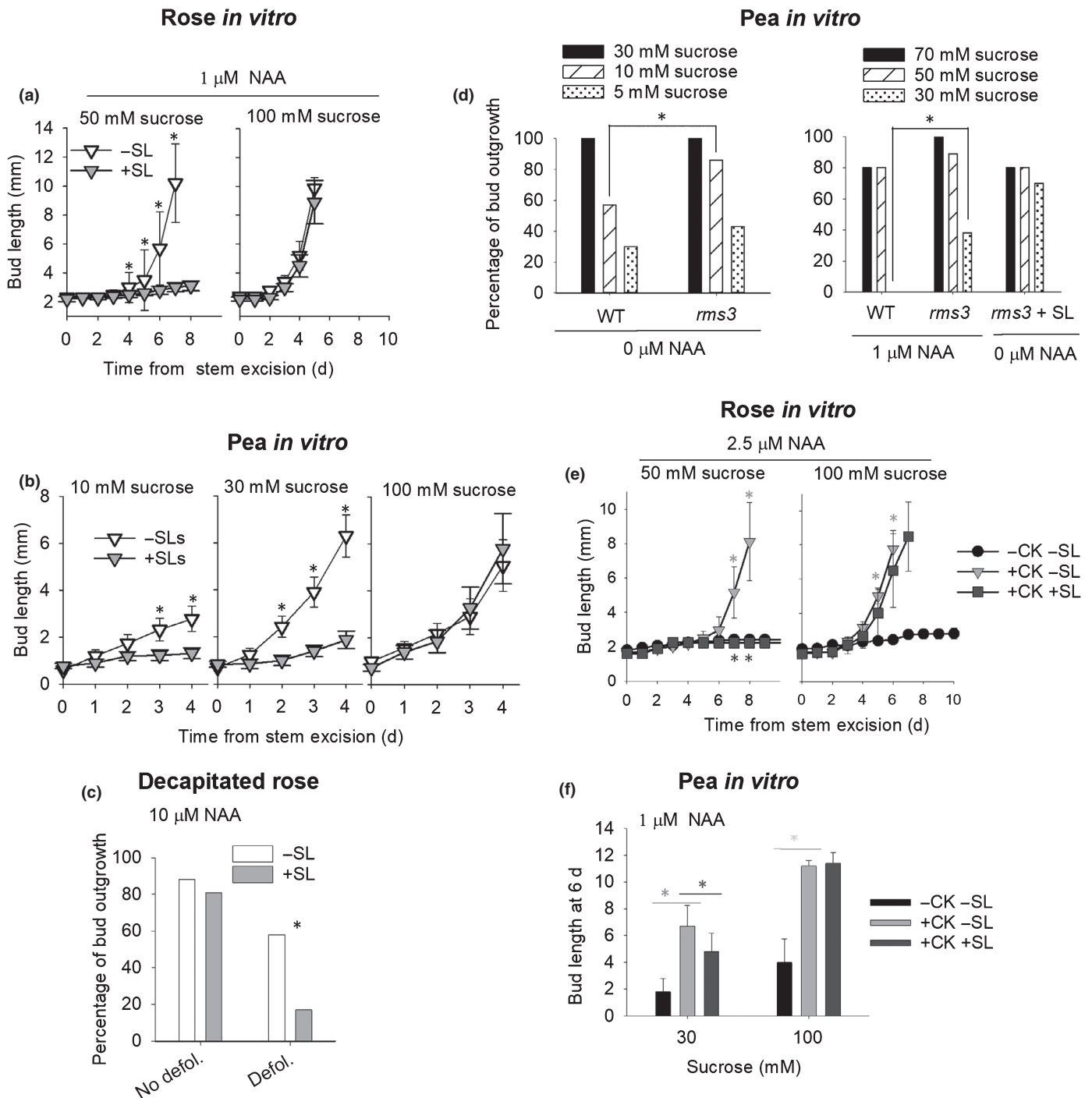

Fig. 4 Sucrose suppresses bud outgrowth response to strigolactones and *rms3* mutant displays a reduced response to a decrease in sucrose level. (a, b) Bud outgrowth response to GR24, a synthetic strigolactone (-SL/+SL), for nodal segments of rose (a) and pea (b) grown *in vitro* with increasing sucrose concentrations. Data represent the bud with the median final length ($n = 10$ buds for rose and $n = 9$ buds for pea). Asterisks indicate significant differences between GR24 treatments (Wilcoxon's test; $P < 0.01$). For rose, the medium is supplemented with NAA (1 μM). (c) Impact of GR24 supply (-SL/+SL) on bud outgrowth percentage of rose plants, previously decapitated and either nondefoliated (no defol.) or partially defoliated (defol.) ($n = 8$). Only the buds above the point of GR24 supply are considered. Asterisks indicate a significant effect of GR24 (Fisher's exact test; $P < 0.1$). (d) Sucrose impact on the percentage of bud outgrowth for wild-type plants of garden pea and *rms3* mutant deficient in a strigolactone signalling gene. Nodal segments were grown *in vitro* without or with NAA (a synthetic auxin), or GR24 (+SL) and a range of sucrose concentrations (5, 10, 30 mM under 0 μM NAA; 30, 50, 70 mM under 1 μM NAA). A bud was considered to grow out when its length was above 3 mm. Asterisks indicate significant differences between treatments ($n = 9$ to 12; Fisher's exact test; $P < 0.1$). (e, f) Impact of supplying BAP (+CK -SL) and BAP plus GR24 (+CK +SL) on bud outgrowth for nodal segments of rose (e) and pea (f) grown *in vitro* at two sucrose concentrations: (e) observed elongation kinetics of the bud with the median final length ($n = 10$); (f) observed median bud length at 6 d ($n = 9$). Light grey asterisks indicate a significant effect of BAP supply (-CK -SL vs +CK -SL), dark grey asterisks indicate a significant effect of GR24 supply in the presence of BAP (+CK -SL vs +CK +SL) (Wilcoxon's test; $P < 0.05$). For all graphs, error bars represent 95% confidence intervals.

bud outgrowth in the presence or absence of NAA. However, by contrast with wild-type, bud outgrowth of *rms3* was not as inhibited when sucrose was reduced to 10 mM in the absence of NAA, or to 30 mM in the presence of NAA, or to 30 mM in the presence of GR24. This reduced response to a decrease in sucrose concentration in the strigolactone-perception mutant *rms3* supported the involvement of the strigolactone pathway in sugar-stimulated bud outgrowth.

Auxin inhibition of bud outgrowth involves an antagonistic effect between strigolactones and cytokinins (Domagalska & Leyser, 2011; Dun *et al.*, 2012). To determine if sugar disrupts the antagonistic action of strigolactones and cytokinins on bud outgrowth, we supplied BAP and GR24 to rose and pea nodal segments *in vitro* at two sucrose levels (50 or 30 mM for rose and pea, respectively, and 100 mM for both species) and observed the bud outgrowth that ensued. NAA was supplied at a quantity sufficient to inhibit bud outgrowth in the absence of cytokinin for both species. As described previously (Fig. 3b), the addition of BAP stimulated bud outgrowth at both sucrose levels (Fig. 4e,f). However, the addition of GR24 antagonised the positive effect of BAP only at the lower sucrose level and not at the higher sucrose level. This finding suggests that the pathway for strigolactones that are involved in an auxin effect is not able to inhibit bud outgrowth in high sugar environments.

A computational model, in which sugar suppresses strigolactone pathway, captures the diversity of dose-dependent observations in a quantitative manner

Taken together, our biological results indicated that the antagonism of sugar to auxin on bud outgrowth involves sugar suppression of the strigolactone response. To check whether this hypothesis could be quantitatively sufficient to explain the diversity of biological effects of sucrose and hormones on bud outgrowth, we constructed a computational model of our putative sugar-hormone network (Fig. 5a) and tested its ability to reproduce quantitatively the range of phenotypes resulting from sucrose and hormone crosstalk experiments. The inputs of the model correspond to the levels of sucrose and auxin; the output is the time at which bud outgrowth starts, which is either infinite (no bud outgrowth) or initiates at different time points. The model relies on the following assumptions. According to the published literature, auxin (1) suppresses cytokinin synthesis (Tanaka *et al.*, 2006; Figs 3a, S3); and (2) enhances strigolactone synthesis (Hayward *et al.*, 2009). Cytokinins and strigolactones induce responses that are integrated antagonistically at the bud and control bud outgrowth (Dun *et al.*, 2012). According to our results, sucrose suppresses the strigolactone response (Fig. 4) without significantly altering strigolactone synthesis (Barbier *et al.*, 2015b). Conversely, sucrose causes only a small enhancement of cytokinin content (Figs 3a, S3). We modelled these interactions using a set of coupled ordinary differential equations to account for the quantitative variations of the different variables (see the Materials and Methods section).

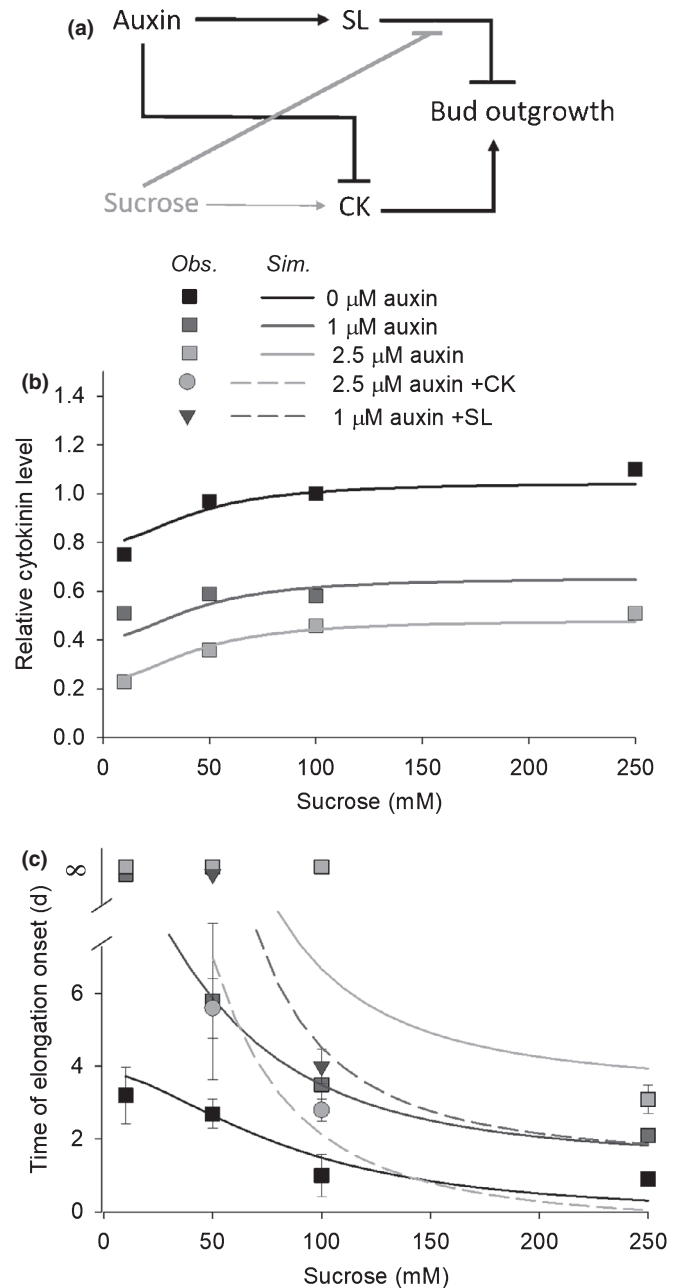

Fig. 5 A model including sucrose as a suppressor of strigolactone response captures all observed crosstalks between sucrose and hormones. (a) A model of sucrose crosstalk with auxin in bud outgrowth control. Sucrose suppresses auxin-induced strigolactone pathway and causes only a small increase in the level of auxin-repressed cytokinins. (b, c) Simulated (lines) and observed (symbols) nodal cytokinin levels (b) and times at which bud elongation starts (c) for nodal segments of rose grown *in vitro* at different sucrose levels, auxin levels, without or with cytokinins and strigolactones (+CK, +SL). In (c), observations of an absence of bud elongation are represented by an infinite time at which elongation starts (∞). For simulations, bud elongation is completely prevented above a threshold of 8.3 d. Observed cytokinin levels were calculated as detailed in Supporting Information Table S4. Observed times at which elongation starts are those of Fig. 2(d) and those calculated from Figs 3(b), 4(a) (see Methods S3 for calculation details). Error bars represent 95% confidence intervals.

As the kinetic parameter values involved in these equations are mostly unknown in the published literature, we sought to estimate these values using our *in vitro* rose experiments. These experiments provided measurable outputs corresponding to controlled input levels. We then used these observed pairs of input/output to find the most plausible parameter values of the model to account for all our biological observations, namely the bud outgrowth responses to the different concentrations and combinations of sucrose, auxin, cytokinins and strigolactones (Figs 2–4). For this, we used a systematic exploration of the parameter space, constraining the model to the observed endogenous cytokinin levels (Fig. 5b) and to the observed time at which elongation starts for the available experimental data and treatments (Fig. 5c). From this analysis, we discovered a relatively narrow region of the parameter space in which the model can optimally reproduce the observed interactions between sucrose and hormones. In this region, the model captured the conditions of hormone and sucrose levels for bud elongation as well as the time at which bud elongation starts (Fig. 5c). In particular, it accounted for the sucrose \times auxin interaction effect that was observed in the time at which outgrowth started.

Bud outgrowth is controlled by a simple variable combining both sucrose and auxin levels

Our modelling and experimental work shows that different combinations of sucrose and auxin levels can result in identical (or close to identical) bud outgrowth responses (e.g. similar outgrowth response time for 1 μ M NAA/100 mM sucrose and for 2.5 μ M NAA/250 mM sucrose). This results from the antagonistic effect of the two input factors. For example, starting from given levels of auxin and sucrose, increasing the auxin level (i.e. increasing inhibition) can be compensated for by an adequate increase in the sucrose level (increasing bud outgrowth release). We wondered whether we could extract a law from the model to help us quantitatively predict how to maintain balance between the two antagonistic factors. Based on the model's equations at equilibrium, we analysed different algebraic combinations of the input variables and found one that made it possible to summarise the system's overall behaviour using a simple combination of the input levels of auxin (A) and sucrose (S):

$$\alpha = \frac{A + 1}{S + 0.2} \left(1 - \frac{0.15}{S + 0.2} \right).$$

This variable, α , combines auxin and sucrose levels so that each value of α defines a unique time at which bud outgrowth starts, through a close-to-linear function of α (Fig. 6). Interestingly, other combinations of auxin and sucrose levels would not lead to a similar one-to-one relationship (Fig. S6). We call α a control variable for bud outgrowth. This control variable allows us to summarise efficiently the behaviour of the system without needing to know or to run the model: at high sucrose levels, the time at which outgrowth starts is basically a linear function of the ratio between simple affine functions of auxin and sucrose levels ($\frac{A+1}{S+0.2}$); at low sucrose levels, this ratio is decreased by a correcting term $\left(1 - \frac{0.15}{S+0.2} \right)$.

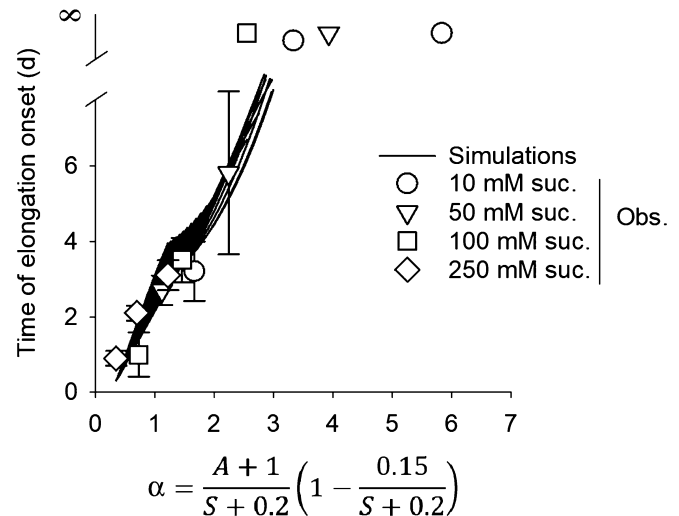

Fig. 6 Bud outgrowth is controlled by a simple variable combining both sucrose and auxin levels. Relationship between (1) the time at which elongation starts and (2) the ratio between affine functions of auxin and sucrose levels $\left(\frac{A+1}{S+0.2} \right)$, modulated by a sucrose-dependent correcting term $\left(1 - \frac{0.15}{S+0.2} \right)$. The different lines show simulations for different sucrose levels and the different symbols the biological observations for nodal segments of rose *in vitro* grown at different sucrose levels (Obs.). Observations of an absence of bud elongation are represented by a time at which elongation starts which is infinite (∞). For simulations, bud elongation is completely prevented above a threshold of 8.3 d. Error bars represent 95% confidence intervals. A , auxin level; S , sucrose level.

Discussion

Apical dominance results in growth in height at the expense of lateral growth by inhibiting axillary buds. In the classical view, auxin is a signal that indicates the presence of growing apical organs and that inhibits the outgrowth of axillary buds at the nodes below (Ongaro & Leyser, 2008). Together with results demonstrating that sugars are a positive signal for bud outgrowth (Rabot *et al.*, 2012; Barbier *et al.*, 2015b; Fichtner *et al.*, 2017), the recent study by Mason *et al.* (2014) on garden pea has drawn attention to the role of the growing apical shoot tip in creating a sugar demand that diverts sugars from the axillary buds and inhibits their outgrowth. Using model species rose and pea, and isolated nodal segments and decapitated plants to modulate both sugar and auxin levels for buds, we showed that bud outgrowth is under an antagonistic coupled control of sugar and auxin levels. More precisely, the ratio between simple functions of sugar and auxin levels determines both if a bud grows out and the time at which growth starts (the modulo being a correction term at low sugar level). These results bring the idea that plant sugar status modulates auxin-related apical dominance. In this perspective, auxin produced by the growing shoot tip results in strong apical dominance only if the sugar status of the plant is low. When the plant sugar status is high, apical dominance is reduced, leading to bushy phenotypes. Consistently, a recent transcriptomic study highlighted that bud dormancy is, at least partly, maintained by carbon starvation syndrome in annual and perennial plants (Tarancon *et al.*, 2017). Moreover, bud outgrowth is influenced

by modulating either sources (exogenous sugar supply, partial defoliation, CO₂ supply) or sinks (decapitation, *tin* mutation) for sugars (Kebrom *et al.*, 2012; Mason *et al.*, 2014; Kebrom & Mullet, 2015; Fichtner *et al.*, 2017; Kebrom, 2017; Otori *et al.*, 2017; Martin-Fontecha *et al.*, 2018).

Sugars could take part in the strong response of plant branching to a myriad of environmental conditions (Rameau *et al.*, 2015). Indeed, the environment impacts the source–sink balance within the plant (Kebrom, 2017) and therefore its sugar status. Under environmental conditions leading to high source–sink balance, plant sugar status is increased and this could result in reduced auxin-related apical dominance and induction of bud outgrowth. In support, experiments have shown that the efficacy of exogenous auxin to inhibit bud outgrowth was reduced under growing conditions such as high light intensities, which promote photosynthesis and sugar status (Gregory & Veale, 1957; Cline, 1996). Sugar status would then provide an internal cue to enable an optimised response to the environment, coordinating investment in lateral growth relative to the whole plant. The dose-dependent effect of sugars that we highlight here could provide a means for plants to fine tune their architecture.

The impact of sugar availability on plant development can be mediated by different pathways involving different sugars (Li & Sheen, 2016; Sakr *et al.*, 2018; Wingler, 2018). A signalling role for sucrose has been reported in rose and pea (Barbier *et al.*, 2015b; Fichtner *et al.*, 2017). Here, we show that sucrose, glucose and fructose could all trigger bud outgrowth and antagonise the effect of auxin and SL on bud outgrowth. In addition, glucose and fructose are more efficient than sucrose. These findings indicate that metabolic and/or signalling pathways downstream of glucose and fructose could be involved in this regulation. More investigation is thus required in the near future to decipher the complexity of the sugar signalling pathways involved in bud outgrowth.

Surprisingly, we found little evidence that cytokinin levels mediate the antagonistic effect of sugar to auxin. Cytokinins are positive endogenous signals responsible for the stimulation of tissue sink strength (Roitsch & Ehness, 2000; Werner *et al.*, 2008; Roman *et al.*, 2016) and of bud outgrowth by light or nitrogen nutrition (Takei *et al.*, 2002; Kamada-Nobusada *et al.*, 2013; Roman *et al.*, 2016; Corot *et al.*, 2017). Sugars stimulate cytokinin biosynthesis and/or levels under different physiological processes (Barbier *et al.*, 2015b for review). However, we report here that sugar does not antagonise the strong repressing effect of auxin on cytokinin levels at concentrations at which it reduces bud inhibition by auxin. In addition, sugar is still able to promote bud outgrowth in the presence of exogenously supplied cytokinins. Such noninvolvement of cytokinins in the antagonistic effect of sugar to auxin on bud outgrowth is consistent with the result of a recent experiment using *Arabidopsis* cytokinin-deficient mutants (Muller *et al.*, 2015). In this experiment, decapitation, which is thought to stimulate bud outgrowth by increasing plant sugar status, led to highly branched phenotypes for both wild-type plants and cytokinin-deficient mutants. Additionally, excised single nodes of these mutants did not display any increased responsiveness to auxin when grown *in vitro* on

medium containing sucrose (Muller *et al.*, 2015). Consequently, modulation of cytokinin levels was clearly not critical for the decapitation response and for sucrose-dependent bud outgrowth (Barbier *et al.*, 2019). However, further study should clarify whether sugar could affect cytokinin signalling to regulate bud outgrowth, as it does in the regulation of root growth (Kushwah *et al.*, 2011; Kushwah & Laxmi, 2017).

We highlight that sugar supply inhibits strigolactone response to promote bud outgrowth. Strigolactones inhibit bud outgrowth and mediate the effect of auxin (Beveridge *et al.*, 2000; Zou *et al.*, 2006; Hayward *et al.*, 2009) as well as the response to different abiotic stresses that modulate strigolactone synthesis (phosphate or nitrogen deficiency) or signalling (drought) (Ume-hara *et al.*, 2010; Kohlen *et al.*, 2011; Bu *et al.*, 2014; Ha *et al.*, 2014; Saeed *et al.*, 2017). We show that sugar supply is able to repress the inhibitory effect of strigolactones on buds, as is the case for strigolactone-induced bamboo leaf senescence in the dark (Tian *et al.*, 2018). Moreover, *rms3*, a strigolactone-perception pea mutant, exhibited a reduced inhibition with decreasing sucrose concentration. This result also holds true for seedling development of *max2*, a strigolactone signalling mutant, that displayed a reduced response to sugar (Li *et al.*, 2016). This effect of sugar on bud outgrowth through the strigolactone pathway matches with the sucrose-mediated repression of *MAX2* expression in rose buds (Barbier *et al.*, 2015b) and the downregulation of *MAX2* in response to defoliation and shade in sorghum (Kebrom *et al.*, 2010). Moreover, in rose and pea, sucrose inhibited the expression of *BRC1* (Mason *et al.*, 2014; Barbier *et al.*, 2015b), encoding a transcription factor that inhibited bud outgrowth (Aguilar-Martinez *et al.*, 2007) and was also involved in strigolactone signalling (Braun *et al.*, 2012; Dun *et al.*, 2012; Dun *et al.*, 2013; Seale *et al.*, 2017). Collectively, these findings prompted us to identify the molecular components of the strigolactone signalling involved in the sugar-mediated bud outgrowth promotion.

Previous results highlighted an effect of sugars on auxin signalling pathways on bud outgrowth (Rabot *et al.*, 2012; Barbier *et al.*, 2015b; Fichtner *et al.*, 2017). We further propose a simple model in which sugar and auxin interact in bud outgrowth regulation through modulation of the balance between cytokinins and strigolactones. This balance is a quantitative regulator that determines both whether a bud grows out and the time at which it grows out. This simple model is sufficient to capture the variety of bud outgrowth responses *in vitro* to sucrose level, auxin level and cytokinins and strigolactones. Like all models, it is a simplification of physiological reality and does not exclude the involvement of other mechanisms. In particular, it does not explicitly account for the role of auxin canalisation out of the bud in controlling its outgrowth. However, auxin canalisation is not involved in early outgrowth regulation (Chabikwa *et al.*, 2018) and could be considered as a mechanism downstream of cytokinin and strigolactone signalling such as *BRC1* (Dun *et al.*, 2012), as both hormones also regulate canalisation (Shinohara *et al.*, 2013; Waldie & Leyser, 2018).

In conclusion, we demonstrate that bud outgrowth quantitatively adjusts to the balance between sugar and auxin level, with

increased sugar leading to a strong reduction of bud inhibition by auxin and that the sugar effect involves repression of the strigolactone response. As mentioned above, high sugar levels may explain a reduction in apical dominance in response to environmental or genetic factors that increase the source–sink balance within the plant. In addition to sugar, cytokinins and strigolactones have been shown to be involved in branching in response to several environmental factors (Takei *et al.*, 2002; Drummond *et al.*, 2015; Roman *et al.*, 2016; Saeed *et al.*, 2017). We suggest that our network involving auxin, sugars, cytokinins and strigolactones may be a key integrator of the plant growth status and environmental conditions, to dynamically adapt plant architecture and therefore contribute to plant plasticity.







Acknowledgements

We thank Bénédicte Dubuc and the ImHorPhen team (UMR IRHS, France) for rose production, Hervé Autret for computer help, Catherine Rameau and François-Didier Boyer (IJPB, Versailles, France) for providing the seeds of *Pisum sativum* and GR24. We also would like to thank John Lunn (Max Planck Institute, Germany) for fruitful conversations. We thank the Environment and Agronomy department of INRA for financial support.

Author contributions

JB, CG and SS designed the research. JB, FBarbier, MDP, TP, SC, performed the experiments and analysed the data. JB, FBoudon and CG designed the model and the link between experiments and modelling and analysed the simulations. JB, FBarbier, FBoudon, ED, CB, CG, SS contributed to manuscript writing. JB and FBarbier contributed equally to the work.

ORCID

Jessica Bertheloot  <https://orcid.org/0000-0001-5941-2227>
Christine Beveridge  <https://orcid.org/0000-0003-0878-3110>
Frédéric Boudon  <https://orcid.org/0000-0001-9636-3102>
Sylvie Citerne  <https://orcid.org/0000-0001-5026-095X>
Elizabeth Dun  <https://orcid.org/0000-0003-4068-0349>
Christophe Godin  <https://orcid.org/0000-0002-1202-8460>
Soulaïman Sakr  <https://orcid.org/0000-0003-1407-2585>

References

- Aguilar-Martínez JA, Poza-Carrion C, Cubas P. 2007. Arabidopsis *BRANCHED1* acts as an integrator of branching signals within axillary buds. *Plant Cell* 19: 458–472.
- Arrom L, Munne-Bosch S. 2012. Sucrose accelerates flower opening and delays senescence through a hormonal effect in cut lily flowers. *Plant Science* 188: 41–47.
- Balla J, Kalousek P, Reinohl V, Friml J, Prochazka S. 2011. Competitive canalization of PIN-dependent auxin flow from axillary buds controls pea bud outgrowth. *The Plant Journal* 65: 571–577.
- Barbier F, Lunn JE, Beveridge CA. 2015a. Ready, steady, go! A sugar hit starts the race to shoot branching. *Current Opinion in Plant Biology* 25: 39–45.
- Barbier F, Peron T, Lecerf M, Perez-Garcia MD, Barriere Q, Rolcik J, Boutet-Mercey S, Citerne S, Lemoine R, Porcheron B *et al.* 2015b. Sucrose is an early modulator of the key hormonal mechanisms controlling bud outgrowth in *Rosa hybrida*. *Journal of Experimental Botany* 66: 2569–2582.
- Barbier FF, Dun EA, Kerr SC, Chabikwa TG, Beveridge CA. 2019. An update on the signals controlling shoot branching. *Trends in Plant Science* 24: 220–236.
- Beveridge CA, Symons GM, Turnbull CGN. 2000. Auxin inhibition of decapitation-induced branching is dependent on graft-transmissible signals regulated by genes *rms1* and *rms2*. *Plant Physiology* 123: 689–697.
- Booker J, Chatfield S, Leyser O. 2003. Auxin acts in xylem-associated or medullary cells to mediate apical dominance. *Plant Cell* 15: 495–507.
- Braun N, de Saint Germain A, Pillot JP, Boutet-Mercey S, Dalmais M, Antoniadis I, Li X, Maia-Grondard A, Le Signor C, Bouteiller N *et al.* 2012. The pea TCP transcription factor PsBRC1 acts downstream of strigolactones to control shoot branching. *Plant Physiology* 158: 225–238.
- Brewer PB, Dun EA, Gui RY, Mason MG, Beveridge CA. 2015. Strigolactone inhibition of branching independent of polar auxin transport. *Plant Physiology* 168: 1820–U1215.
- Bu QY, Lv TX, Shen H, Luong P, Wang J, Wang ZY, Huang ZG, Xiao LT, Engineer C, Kim TH *et al.* 2014. Regulation of drought tolerance by the F-Box protein MAX2 in Arabidopsis. *Plant Physiology* 164: 424–439.
- Cerasoll S, Scartazza A, Brugnoli E, Chaves MM, Pereira JS. 2004. Effects of partial defoliation on carbon and nitrogen partitioning and photosynthetic carbon uptake by two-year-old cork oak (*Quercus suber*) saplings. *Tree Physiology* 24: 83–90.
- Chabikwa TG, Brewer PB, Beveridge C. 2018. Initial bud outgrowth occurs independent of auxin flow out of buds. *Plant Physiology* 179: 55–65.
- Chatfield SP, Stirnberg P, Forde BG, Leyser O. 2000. The hormonal regulation of axillary bud growth in Arabidopsis. *The Plant Journal* 24: 159–169.
- Chiou TJ, Bush DR. 1998. Sucrose is a signal molecule in assimilate partitioning. *Proceedings of the National Academy of Sciences, USA* 95: 4784–4788.
- Cline MG. 1996. Exogenous auxin effects on lateral bud outgrowth in decapitated shoots. *Annals of Botany* 78: 255–266.
- Corot A, Roman H, Douillet O, Autret H, Perez-Garcia MD, Citerne S, Bertheloot J, Sakr S, Leduc N, Demotes-Mainard S. 2017. Cytokinins and abscisic acid act antagonistically in the regulation of the bud outgrowth pattern by light intensity. *Frontiers in Plant Science* 8: article 1724.
- Crawford S, Shinohara N, Sieberer T, Williamson L, George G, Hepworth J, Muller D, Domagalska MA, Leyser O. 2010. Strigolactones enhance competition between shoot branches by dampening auxin transport. *Development* 137: 2905–2913.
- de Saint Germain A, Clave G, Badet-Denisot MA, Pillot JP, Cornu D, Le Caer JP, Burger M, Pelissier F, Retailleau P, Turnbull C *et al.* 2016. An histidine covalent receptor and butenolide complex mediates strigolactone perception. *Nature Chemical Biology* 12: 787–794.
- Domagalska MA, Leyser O. 2011. Signal integration in the control of shoot branching. *Nature Reviews Molecular Cell Biology* 12: 211–221.
- Drummond RSM, Janssen BJ, Luo ZW, Oplaat C, Ledger SE, Wohlers MW, Snowden KC. 2015. Environmental control of branching in *Petunia*. *Plant Physiology* 168: 735–751.
- Dun EA, de Saint Germain A, Rameau C, Beveridge CA. 2012. Antagonistic action of strigolactone and cytokinin in bud outgrowth control. *Plant Physiology* 158: 487–498.
- Dun EA, de Saint Germain A, Rameau C, Beveridge CA. 2013. Dynamics of strigolactone function and shoot branching responses in *Pisum sativum*. *Molecular Plant* 6: 128–140.
- Evers JB, van der Krol AR, Vos J, Struik PC. 2011. Understanding shoot branching by modelling form and function. *Trends in Plant Science* 16: 464–467.
- Eyles A, Pinkard EA, Davies NW, Corkrey R, Churchill K, O'Grady AP, Sands P, Mohammed C. 2013. Whole-plant versus leaf-level regulation of photosynthetic responses after partial defoliation in *Eucalyptus globulus* saplings. *Journal of Experimental Botany* 64: 1625–1636.
- Fichtner F, Barbier F, Feil R, Watanabe M, Annunziata MG, Chabikwa TG, Höfgen R, Stitt M, Beveridge CA, Lunn JE. 2017. Trehalose 6-phosphate is

- involved in triggering axillary bud outgrowth in garden pea (*Pisum sativum* L.). *The Plant Journal* 92: 611–623.
- Figueroa CM, Lunn JE. 2016. A tale of two sugars: trehalose 6-phosphate and sucrose. *Plant Physiology* 172: 7–27.
- Foo E, Buillier E, Goussot M, Foucher F, Rameau C, Beveridge CA. 2005. The branching gene *RAMOSUS1* mediates interactions among two novel signals and auxin in pea. *Plant Cell* 17: 464–474.
- Gomez-Roldan V, Fermas S, Brewer PB, Puech-Pages V, Dun EA, Pillot JP, Letisse F, Matusova R, Danoun S, Portais JC *et al.* 2008. Strigolactone inhibition of shoot branching. *Nature* 455: 189–U122.
- Gregory FC, Veale JA. 1957. A reassessment of the problem of apical dominance. *Symposia of Society of Experimental Botany* 11: 1–20.
- Ha CV, Leyva-Gonzalez MA, Osakabe Y, Tran UT, Nishiyama R, Watanabe Y, Tanaka M, Seki M, Yamaguchi S, Dong NV *et al.* 2014. Positive regulatory role of strigolactone in plant responses to drought and salt stress. *Proceedings of the National Academy of Sciences, USA* 111: 851–856.
- Hayward A, Stirnberg P, Beveridge C, Leyser O. 2009. Interactions between auxin and strigolactone in shoot branching control. *Plant Physiology* 151: 400–412.
- Jensen KH, Kim W, Holbrook NM, Bush JWM. 2013. Optimal concentrations in transport systems. *Journal of the Royal Society Interface* 10.
- Kamada-Nobusada T, Makita N, Kojima M, Sakakibara H. 2013. Nitrogen-dependent regulation of *de novo* cytokinin biosynthesis in rice: the role of glutamine metabolism as an additional signal. *Plant and Cell Physiology* 54: 1881–1893.
- Kebrom TH. 2017. A growing stem inhibits bud outgrowth – the overlooked theory of apical dominance. *Frontiers in Plant Science* 8: article 1874.
- Kebrom TH, Brutnell TP, Finlayson SA. 2010. Suppression of sorghum axillary bud outgrowth by shade, *phyB* and defoliation signalling pathways. *Plant, Cell & Environment* 33: 48–58.
- Kebrom TH, Chandler PM, Swain SM, King RW, Richards RA, Spielmeyer W. 2012. Inhibition of tiller bud outgrowth in the *tin* mutant of wheat is associated with precocious internode development. *Plant Physiology* 160: 308–318.
- Kebrom TH, Mullet JE. 2015. Photosynthetic leaf area modulates tiller bud outgrowth in sorghum. *Plant, Cell & Environment* 38: 1471–1478.
- Kohlen W, Charnikhova T, Liu Q, Bours R, Domagalska MA, Beguerie S, Verstappen F, Leyser O, Bouwmeester H, Ruyter-Spira C. 2011. Strigolactones are transported through the xylem and play a key role in shoot architectural response to phosphate deficiency in nonarbuscular mycorrhizal host *Arabidopsis*. *Plant Physiology* 155: 974–987.
- Kushwah S, Jones AM, Laxmi A. 2011. Cytokinin interplay with ethylene, auxin, and glucose signaling controls *Arabidopsis* seedling root directional growth. *Plant Physiology* 156: 1851–1866.
- Kushwah S, Laxmi A. 2017. The interaction between glucose and cytokinin signaling in controlling *Arabidopsis thaliana* seedling root growth and development. *Plant Signaling & Behavior* 12: e1312241.
- Lemoine R, La Camera S, Atanassova R, Deedaldechamp F, Allario T, Pourtau N, Bonnemain JL, Laloi M, Coutos-Thevenot P, Mauroussat L *et al.* 2013. Source-to-sink transport of sugar and regulation by environmental factors. *Frontiers in Plant Science* 4: article 272.
- Lestienne F, Thornton B, Gastal F. 2006. Impact of defoliation intensity and frequency on N uptake and mobilization in *Lolium perenne*. *Journal of Experimental Botany* 57: 997–1006.
- Li GD, Pan LN, Jiang K, Takahashi I, Nakamura H, Xu YW, Asami T, Shen RF. 2016. Strigolactones are involved in sugar signaling to modulate early seedling development in *Arabidopsis*. *Plant Biotechnology* 33: 87–97.
- Li L, Sheen J. 2016. Dynamic and diverse sugar signaling. *Current Opinion in Plant Biology* 33: 116–125.
- Lin YH, Lin MH, Gresshoff PM, Ferguson BJ. 2011. An efficient petiole-feeding bioassay for introducing aqueous solutions into dicotyledonous plants. *Nature Protocols* 6: 36–45.
- Martin-Fontecha ES, Tarancon C, Cubas P. 2018. To grow or not to grow, a power-saving program induced in dormant buds. *Current Opinion in Plant Biology* 41: 102–109.
- Mason MG, Ross JJ, Babst BA, Wienclaw BN, Beveridge CA. 2014. Sugar demand, not auxin, is the initial regulator of apical dominance. *Proceedings of the National Academy of Sciences, USA* 111: 6092–6097.
- Mathan J, Bhattacharya J, Ranjan A. 2016. Enhancing crop yield by optimizing plant developmental features. *Development* 143: 3283–3294.
- Morris SE, Cox MCH, Ross JJ, Krisantini S, Beveridge CA. 2005. Auxin dynamics after decapitation are not correlated with the initial growth of axillary buds. *Plant Physiology* 138: 1665–1672.
- Muller D, Waldie T, Miyawaki K, To JPC, Melnyk CW, Kieber JJ, Kakimoto T, Leyser O. 2015. Cytokinin is required for escape but not release from auxin mediated apical dominance. *The Plant Journal* 82: 874–886.
- Nadwodnik J, Lohaus G. 2008. Subcellular concentrations of sugar alcohols and sugars in relation to phloem translocation in *Plantago major*, *Plantago maritima*, *Prunus persica*, and *Apium graveolens*. *Planta* 227: 1079–1089.
- Nordstrom A, Tarkowski P, Tarkowska D, Norbaek R, Astot C, Dolezal K, Sandberg G. 2004. Auxin regulation of cytokinin biosynthesis in *Arabidopsis thaliana*: a factor of potential importance for auxin-cytokinin-regulated development. *Proceedings of the National Academy of Sciences, USA* 101: 8039–8044.
- Ohshima T, Hayashi H, Chino M. 1990. Collection and chemical-composition of pure phloem sap from *Zea-mays* L. *Plant and Cell Physiology* 31: 735–737.
- Ongaro V, Leyser O. 2008. Hormonal control of shoot branching. *Journal of Experimental Botany* 59: 67–74.
- Otori K, Tamoi M, Tanabe N, Shigeoka S. 2017. Enhancements in sucrose biosynthesis capacity affect shoot branching in *Arabidopsis*. *Bioscience Biotechnology and Biochemistry* 81: 1470–1477.
- Pierik R, Testerink C. 2014. The art of being flexible: how to escape from shade, salt, and drought. *Plant Physiology* 166: 5–22.
- Prusinkiewicz P, Crawford S, Smith RS, Ljung K, Bennett T, Ongaro V, Leyser O. 2009. Control of bud activation by an auxin transport switch. *Proceedings of the National Academy of Sciences, USA* 106: 17431–17436.
- Rabot A, Henry C, Ben Baaziz K, Mortreau E, Azri W, Lothier J, Hamama L, Boumaza R, Leduc N, Pelleschi-Travier S *et al.* 2012. Insight into the role of sugars in bud burst under light in the rose. *Plant and Cell Physiology* 53: 1068–1082.
- Rameau C, Bertheloot J, Leduc N, Andrieu B, Foucher F, Sakr S. 2015. Multiple pathways regulate shoot branching. *Frontiers in Plant Science* 5: article 741.
- Renton M, Hanan J, Ferguson BJ, Beveridge CA. 2012. Models of long-distance transport: how is carrier-dependent auxin transport regulated in the stem? *New Phytologist* 194: 704–715.
- Roitsch T, Ehness R. 2000. Regulation of source/sink relations by cytokinins. *Plant Growth Regulation* 32: 359–367.
- Roman H, Girault T, Barbier F, Péron T, Brouard N, Pencik A, Novak O, Vian A, Sakr S, Lothier J *et al.* 2016. Cytokinins are initial targets of light in the control of bud outgrowth. *Plant Physiology* 172: 489–509.
- Sachs T, Thimann KV. 1967. The role of auxins and cytokinins in the release of buds from dominance. *American Journal of Botany* 54: 136–144.
- Saeed W, Naseem S, Ali Z. 2017. Strigolactones biosynthesis and their role in abiotic stress resilience in plants: a critical review. *Frontiers. Plant Science* 8.
- Sakr S, Wang M, Dedaldechamp F, Perez-Garcia MD, Oge L, Hamama L, Atanassova R. 2018. The sugar-signaling hub: overview of regulators and interaction with the hormonal and metabolic network. *International Journal of Molecular Sciences* 19: 2506
- Seale M, Bennett T, Leyser O. 2017. *BRC1* expression regulates bud activation potential but is not necessary or sufficient for bud growth inhibition in *Arabidopsis*. *Development* 144: 1661–1673.
- Shimizu-Sato S, Tanaka M, Mori H. 2009. Auxin-cytokinin interactions in the control of shoot branching. *Plant Molecular Biology* 69: 429–435.
- Shinohara N, Taylor C, Leyser O. 2013. Strigolactone can promote or inhibit shoot branching by triggering rapid depletion of the auxin efflux protein PIN1 from the plasma membrane. *PLoS Biology* 11: e1001474.
- Sorefan K, Booker J, Haurogne K, Goussot M, Bainbridge K, Foo E, Chatfield S, Ward S, Beveridge C, Rameau C *et al.* 2003. *MAX4* and *RMS1* are orthologous dioxygenase-like genes that regulate shoot branching in *Arabidopsis* and pea. *Genes & Development* 17: 1469–1474.
- Takei K, Takahashi T, Sugiyama T, Yamaya T, Sakakibara H. 2002. Multiple routes communicating nitrogen availability from roots to shoots: a signal

- transduction pathway mediated by cytokinin. *Journal of Experimental Botany* 53: 971–977.
- Tanaka M, Takei K, Kojima M, Sakakibara H, Mori H. 2006. Auxin controls local cytokinin biosynthesis in the nodal stem in apical dominance. *Plant Journal* 45: 1028–1036.
- Tarancon C, Gonzalez-Grando E, Oliveros JC, Nicolas M, Cubas P. 2017. A conserved carbon starvation response underlies bud dormancy in woody and herbaceous species. *Frontiers in Plant Science* 8: 788.
- Thimann KV, Skoog F. 1933. Studies on the growth hormone of plants. III. The inhibitory action of the growth substance on bud development. *Proceedings of the National Academy of Science, USA* 19: 714–716.
- Tian M-q, Jiang K, Takahashi I, Li G-d. 2018. Strigolactone-induced senescence of a bamboo leaf in the dark is alleviated by exogenous sugar. *Journal of Pesticide Science* 43: 173–179.
- Umehara M, Hanada A, Magome H, Takeda-Kamiya N, Yamaguchi S. 2010. Contribution of strigolactones to the inhibition of tiller bud outgrowth under phosphate deficiency in rice. *Plant and Cell Physiology* 51: 1118–1126.
- Umehara M, Hanada A, Yoshida S, Akiyama K, Arite T, Takeda-Kamiya N, Magome H, Kamiya Y, Shirasu K, Yoneyama K *et al.* 2008. Inhibition of shoot branching by new terpenoid plant hormones. *Nature* 455: 195–U129.
- Waldie T, Leyser O. 2018. Cytokinin targets auxin transport to promote shoot branching. *Plant Physiology* 177: 803–818.
- Wang M, Le Moigne MA, Bertheloot J, Crespel L, Perez-Garcia MD, Oge L, Demotes-Mainard S, Hamama L, Daviere JM, Sakr S. 2019. BRANCHED1: a key hub of shoot branching. *Frontiers in Plant Science* 10: 76.
- Werner T, Holst K, Pors Y, Guivarc'h A, Mustroph A, Chriqui D, Grimm B, Schmullig T. 2008. Cytokinin deficiency causes distinct changes of sink and source parameters in tobacco shoots and roots. *Journal of Experimental Botany* 59: 2659–2672.
- Wingler A. 2018. Transitioning to the next phase: the role of sugar signaling throughout the plant life cycle. *Plant Physiology* 176: 1075–1084.
- Zou JH, Zhang SY, Zhang WP, Li G, Chen ZX, Zhai WX, Zhao XF, Pan XB, Xie Q, Zhu LH. 2006. The rice *HIGH-TILLERING DWARF1* encoding an ortholog of Arabidopsis *MAX3* is required for negative regulation of the outgrowth of axillary buds. *The Plant Journal* 48: 687–696.

Supporting Information

Additional Supporting Information may be found online in the Supporting Information section at the end of the article.

Fig. S1 The level of defoliation of decapitated plants modulates sugar level.

Fig. S2 Sucrose antagonises the inhibiting effect of auxin on bud outgrowth for rose nodal stems *in vitro*.

Fig. S3 Cytokinin levels of the nodal stem strongly change with auxin, but not with sucrose.

Fig. S4 10 μ M BAP optimally stimulates bud outgrowth for rose nodal segments *in vitro*.

Fig. S5 Sucrose, glucose and fructose suppress the response of rose buds to strigolactones.

Fig. S6 Deviations from the one-to-one relationship after changes of the control variable α .

Methods S1 *In vitro* cultivation.

Methods S2 Exogenous supply of hormones and sugars in rose decapitated plants.

Methods S3 Estimation of the time at which growth starts.

Methods S4 Sugar content determination.

Table S1 Growth environment for each experiment.

Table S2 Cytokinin quantification: retention times, limit of quantification (LOQ) and limit of detection (LOD)

Table S3 Definition, units and estimated values of the model parameters.

Table S4 Values of the variables used for model calibration.

Please note: Wiley Blackwell are not responsible for the content or functionality of any Supporting Information supplied by the authors. Any queries (other than missing material) should be directed to the New Phytologist Central Office.